

Sink Quadra

Kitchen Sinks

Code: 1236 050



DETAILS

Edge/Installation Type	Flush-mount Top-mount
Finish	Foster brushed
Material	AISI 304 stainless steel
Texture	Brushed in line
Base	45 cm
Dimensions	440x440 mm
Standard fittings	Fixing hooks, gasket, drain, overflow and siphon, boxed packing
Mixer holes	2 standard holes - 3rd and 4th holes on request
Built-in hole	View technical data sheet

Drainer	No
Width	44 cm
Bowl dimension	320x400mm
Number of bowls	1 bowl
Waste fitting	3,5" drain
Notes:	Eclipse mixer tap (8499 000) compatible by swapping the automatic wastefitting with either 8407 116 or 8407 117.

FEATURES

Basket 3,5" waste fitting	The drain is equipped with a large 3.5" drain, with the practical basket cap that prevents the discharge of solid parts.
Deep bowls	This bowls reach an important depth, over 20 cm, thanks to the advanced production technology, that can be offer great capincy and practicity in all the washing operations.
Diamond-shape bottom	The draining of water is an important feature in a sink, and it's always taken good care of in Foster products. In the bent-welded sinks, which would have a flat bottom, the proper draining is guaranteed by the elegant beveling, which helps the water flow.
High thickness	1mm thick steel. A significant thickness, which guarantees the maximum sturdiness and durability.
Perimetral overflow	The overflow is always a security on the Foster sinks that prevents the overflow of water in case of oversights. The perimeter drain solution improves aesthetics thanks to its square and essential shape.
Squared bowls - 0/9 radius	The square bowls of Foster have perfectly squared vertical edges, while those on the bottom have a small radius of 9 mm that facilitates cleaning operations.

TECHNICAL DATA

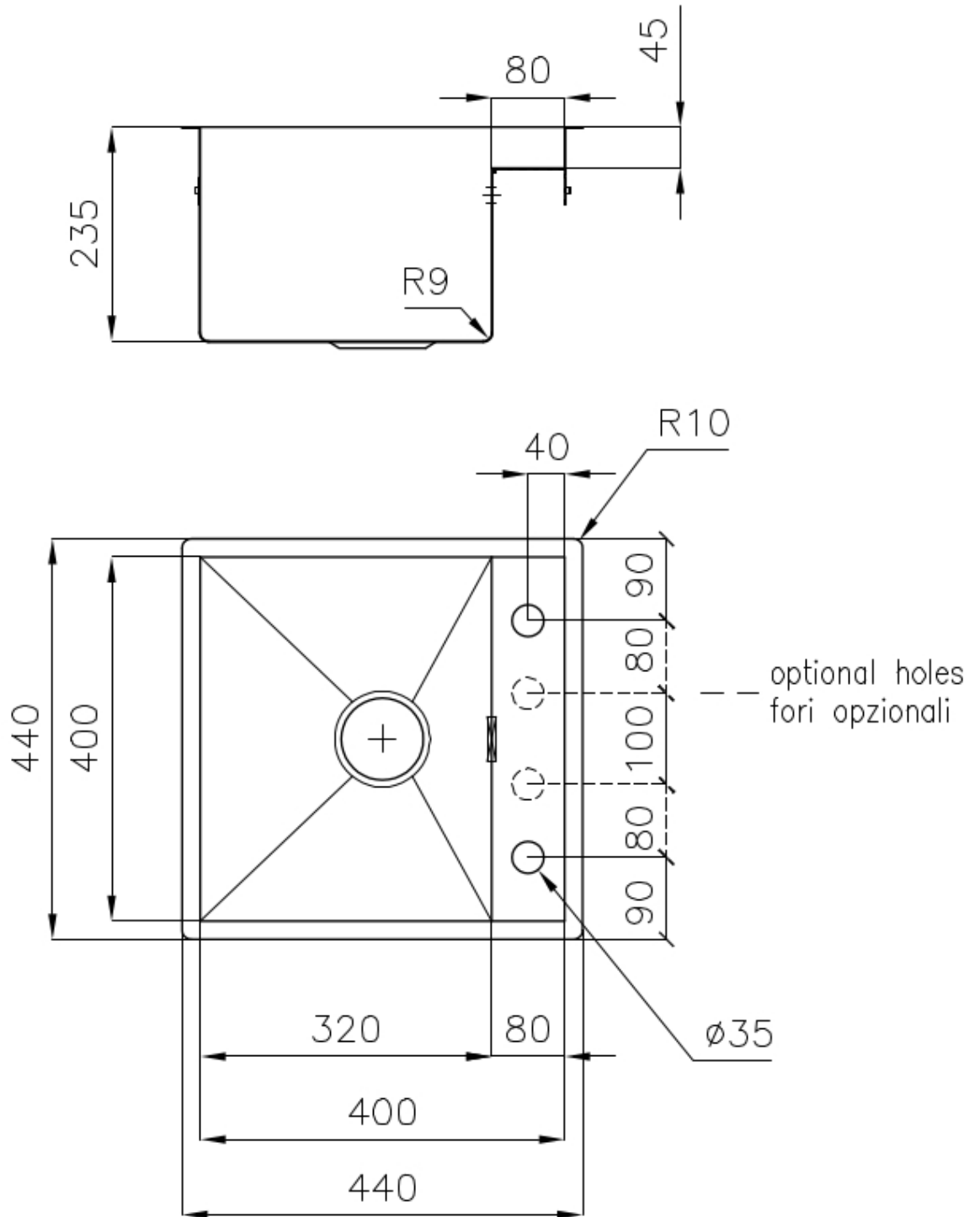

Lavello / Sink cod. 1236 050

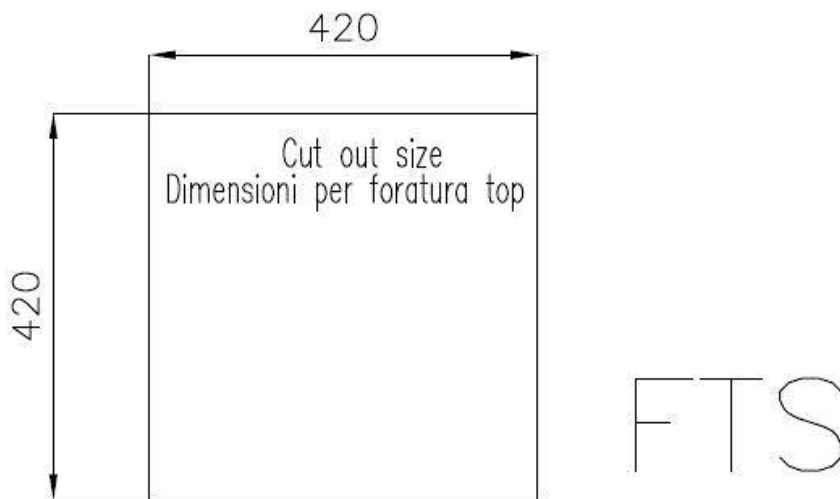
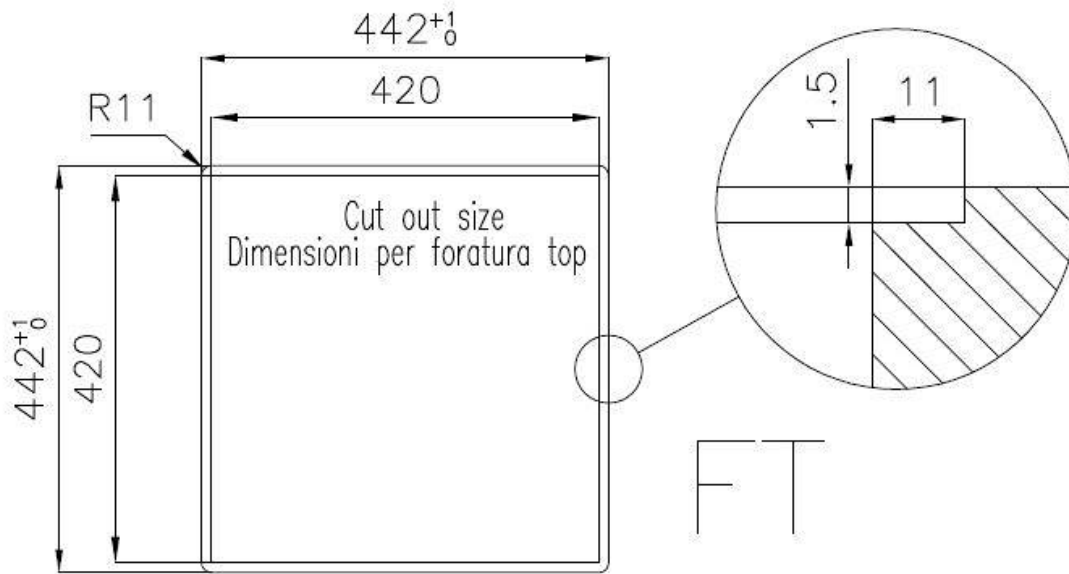

GALLERY



Il lavello può essere installato con banco rubinetteria frontale o laterale.

The sink can be installed with the tap counter on the back or side.



Abbinamento miscelatore Eclipse (8499 000), tagliere Twin (8644 004) e piletta automatica (8407 116 o 8407 117)

Combination of Eclipse mixer tap (8499 000), Twin chopping board (8644 004) and automatic waste fitting (8407 116 or 8407 117)

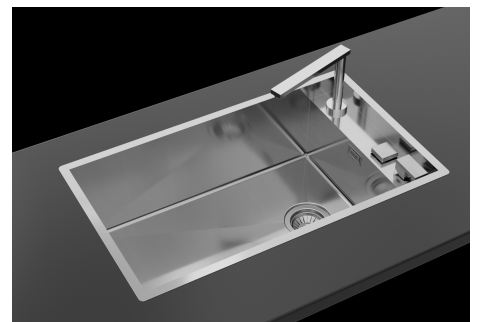

EQUIPMENT



Automatic waste fitting - PM
8407 113

OPTIONAL ACCESSORIES



Glass chopping board
8631 300



HDPE Chopping board
8657 001



HPDE Twin chopping board
8644 101

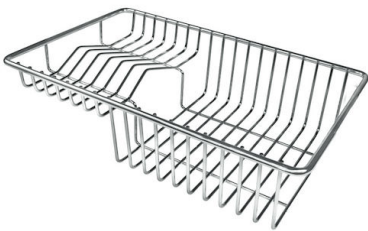

Stainless steel plate rack
8100 303

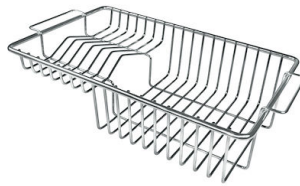

Stainless steel plate rack
8100 201



White bowl
8153 100

* only in combination with the accessory
8644 101



Black grid
8100 617



Graters kit with ring-holder and food collection tray

8159 101

* only in combination with the accessory

8644 101



Iroko-wood sliding chopping board with stainless steel colander

8644 044



Stainless steel perforated tray

8151 000

* only in combination with the accessory

8644 101

RECOMMENDED PAIRINGS



Mixer Tap Eclipse

8499 000

OPTIONAL AUTOMATIC WASTE FITTINGS



Space automatic waste fitting - PA
8407 108



Space automatic waste fitting - PE
8407 109



**Space Light automatic waste fitting
- PL**
8407 117



**Space Milano automatic waste
fitting**
8407 115



**Space Push automatic waste fitting
- PP**
8407 116